



PLD179U

Instruction Manual

WWW.PYLEAUDIO.COM

CAR VIDEO SYSTEM

DVD/MPEG4 PLAYER

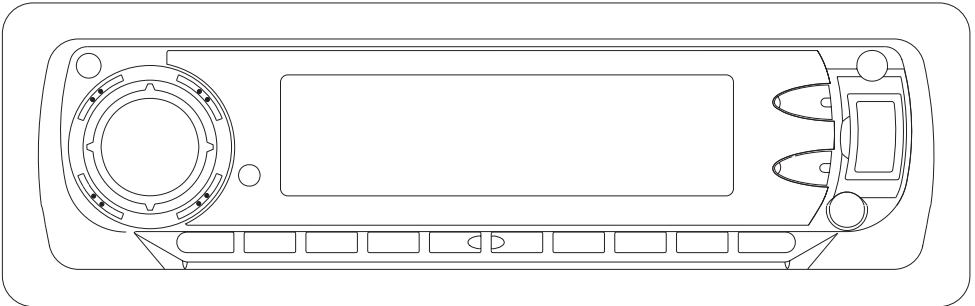

- * AM/FM 2 Band Radio
- * Anti-Shock Mechanism
- * PLL Synthesizer Tuner
- * PAL/NTSC Color System
- * Flip Down Detachable Front Panel
- * A/V Output & A/V Input
- * Sub-woofer Function

CONTENTS

Safety Information	1
Installation	2
Wiring Diagram	4
Operation	5
Location and Function of Keys	5
Preparing The Remote Control	6
Using The Detachable Front Panel	7
General Operation	7
Radio Operation	9
DISC Operation	9
Unique DISC Operation	11
Data Disc Play Operation	13
Memory Card Play Operation	14
USB Play Operation	14
AV In Operation	14
Setup	15
System Setup	15
Language Setup	16
Audio Setup	16
Digital Setup	16
Specification	17
Troubleshooting	17

Safety Information

CAUTION:

Mobile DVD player is a class 1 laser product. However this mobile DVD player uses a visible/invisible laser beam which could cause hazardous radiation exposure if directed. Be sure to operate the mobile DVD player correctly as instructed.

Use of controls or adjustments or performance of procedures other than those specified herein may result in hazardous radiation exposure.

Do not open covers and do not repair yourself. Refer servicing to qualified personnel.

WARNING:

- To reduce the risk of fire or electric shock, do not expose this equipment to rain or moisture.

- To reduce the risk of fire or electric shock, and annoying interference, use only the recommended accessories.

- This device is intended for continuous operation.

This product incorporates copyright protection technology that is protected by method claims of certain U.S. patents and other intellectual property rights owned by macro vision Corporation and other rights owners. Use of this copyright protection technology must be authorized by Macro vision Corporation, and is intended for home and other limited viewing uses only unless otherwise authorized by Macro vision Corporation. Reverse engineering or disassembly is prohibited.

Region Management Information

Region Management Information: This Mobile DVD Player is designed and manufactured to respond to the Region Management Information that is recorded on a DVD disc. If the Region number described on the DVD disc does not correspond to the Region number of this Mobile DVD Player, this Mobile DVD Player cannot play this disc.

Discs you can play

You can playback the following discs- 12CM on the receiver:

DVD VIDEO/DVD AUDIO
VIDEO CD/AUDIO CD
MP3/WMA/JPEG/MPEG4

Handling and Cleaning

- Dirt, dust, scratches and warping discs will cause disoperation.
- Do not place stickers or make scratches on discs.
- Do not warp discs.
- A disc should always be kept in its case when not in use to prevent from damage.
- Do not place discs in the following places:
 1. Direct sunlight.
 2. Dirty, dusty and damp areas.
 3. Near car heaters.
 4. On the seats or dashboard.

Disc Cleaning

Use a dry soft cloth to wipe the surface. If the disc is quite dirty, Use a soft cloth slightly moistures with isopropyl (rubbing) alcohol. Never use solvents such as benzene, thinner or conventional record cleaners as they may mar the surface of the disc.

Note:

A disc may become somewhat scratched (although not enough to make it unusable) depending on the way it is handled and conditions in the usage environment. Note these scratches are not an indication of any problem with the player.

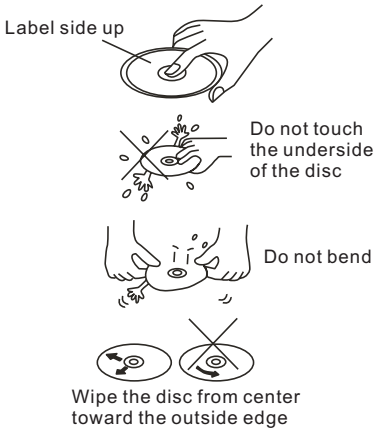

Preparing New Discs with Rough Spots

A new disc may have rough edges on its inside and outside edges. If a disc with rough edges is used, the proper setting will not be performed and the player will not play the disc. Therefore, remove the rough edges in advance by using a ballpoint pen or pencil as shown on the right. To remove the rough edges, press the side of the pen or pencil against the inside and outside edges of the disc.

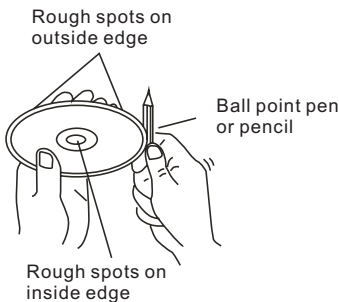

Installation

Notes:

- Choose the mounting location where the unit will not interfere with the normal driving function of the driver.
- Before finally installing the unit, connect the wiring temporarily and make sure it is all connected up properly and the unit and the system work properly.
- Use only the parts included with the unit to ensure proper installation. The use of unauthorized parts can cause malfunctions.
- Consult with your nearest dealer if installation requires the drilling of holes or other modifications of the vehicle.
- Install the unit where it does not get in the driver's way and cannot injure the passenger if there is a sudden stop, like an emergency stop.
- If installation angle exceeds 30° from horizontal, the unit might not give its optimum performance
- Avoid installing the unit where it would be subject to high temperature, such as from direct sunlight, or from hot air, from the heater, or where it would be subject to dust, dirt or excessive vibration.

Din Front/Rear-Mount

This unit can be properly installed either from 'Front' (conventional DIN Front-mount) or 'Rear' (DIN Rear-mount installation, utilizing threaded screw holes at the sides of the unit chassis). For details, refer to the following illustrated installation methods.

Take Out Screw Before Installation

Before install the unit, please remove the two screws.

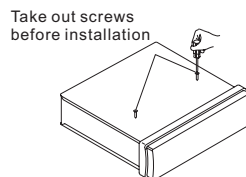

1. DIN Front-Mount(Method A) Installing the unit

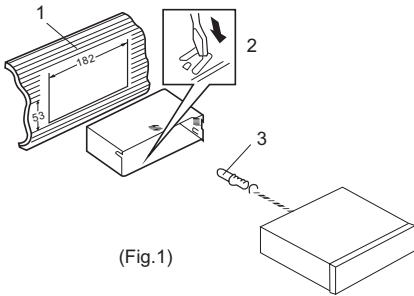

(Fig.1)

1. Dashboard
2. Holder

After inserting the holder into the dashboard, select the appropriate tab according to the thickness of the dashboard material and bend them inwards to secure the holder in place.

3. Screw

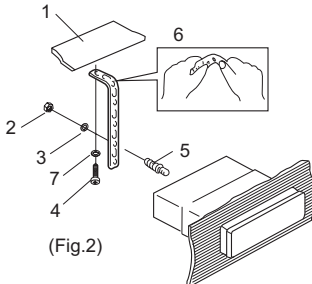

(Fig.2)

1. Dashboard
2. Nut (5mm)
3. Spring washer
4. Screw (5X25mm)
5. Screw

6. Strap

Be sure to use the strap to secure the back of the unit in place. The strap can be bent by hand to the desired angle.

7. Plain washer

Removing the unit

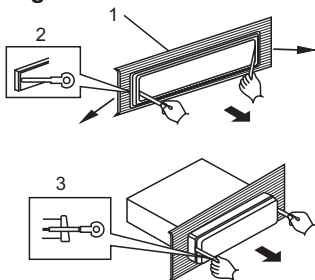

1. Frame
2. Release Frame Key
Insert the release frame key into the groove at the right side of the frame, then pry out to remove the frame (You can also use the key to remove the frame from the left side.)
3. Release Unit Key
After releasing the frame, insert the release unit keys supplied with the accessory into the grooves at both sides of the unit as shown in figure until they click. Pulling the keys makes it possible to remove the unit from the dashboard.

1. DIN Rear-Mount(Method B)

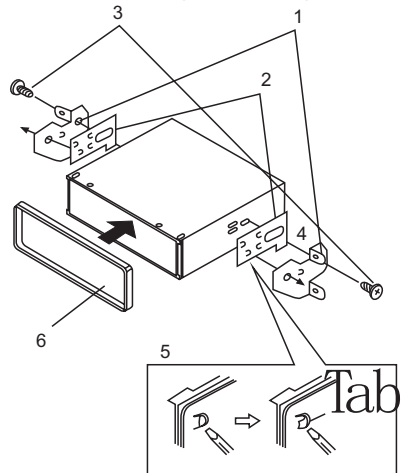

1. Factory-installed radio bracket
2. Car radio mounting bracket
3. Screw
4. After aligning the car radio mounting bracket with the factory-installed radio bracket, tighten the screws (M5X4mm) at 2 places on each side.
5. When fixing factory-installed radio bracket with the screws, use a standard-tipped screwdriver to pry the tabs of the car radio mounting bracket to make them fit into holes in the factory-installed radio bracket.
6. Movable panel frame.

Wiring Diagram

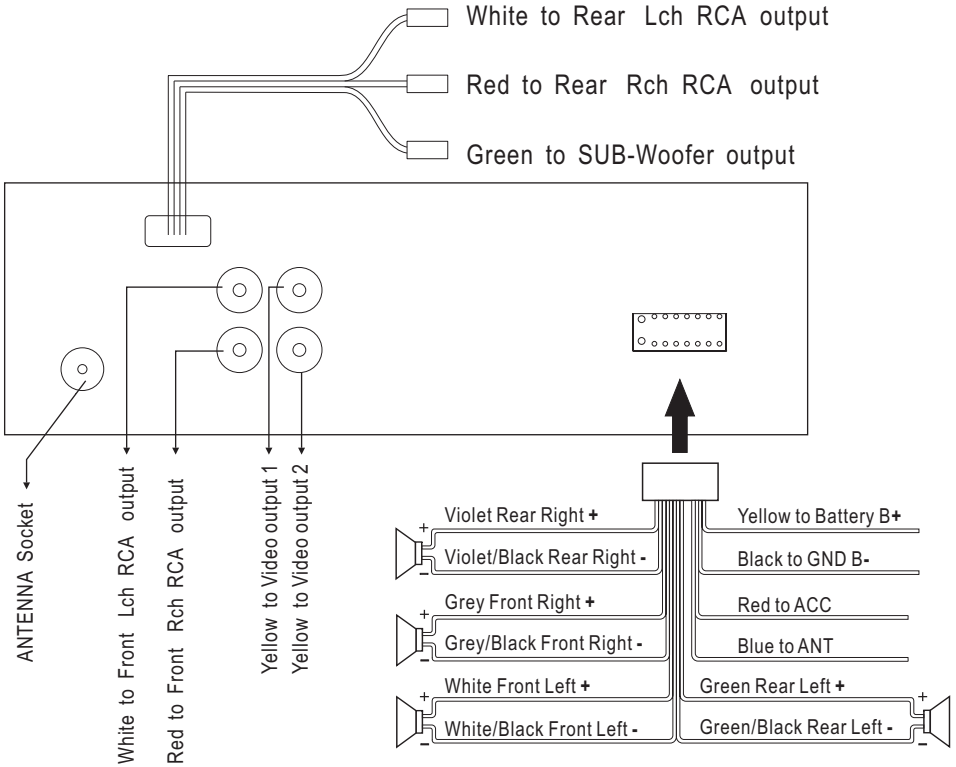

Operation

Location and Function of Keys

Front panel :

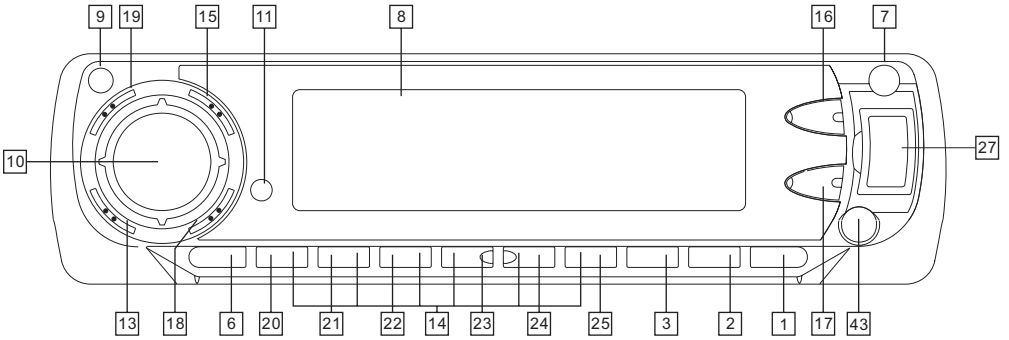

When you press \triangle button (7) and the front panel flip down :

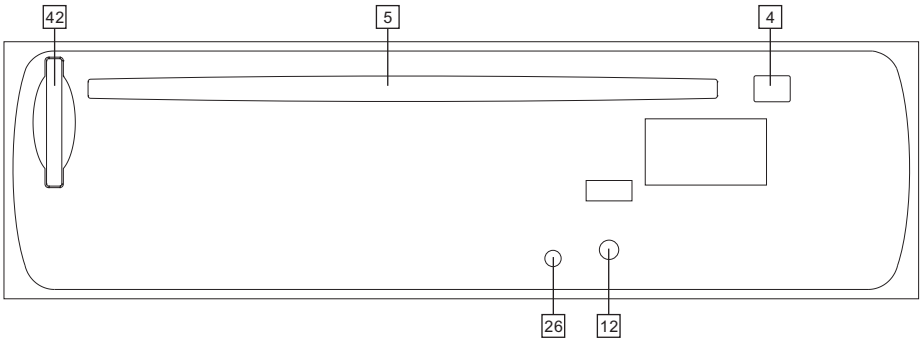

Remote control:

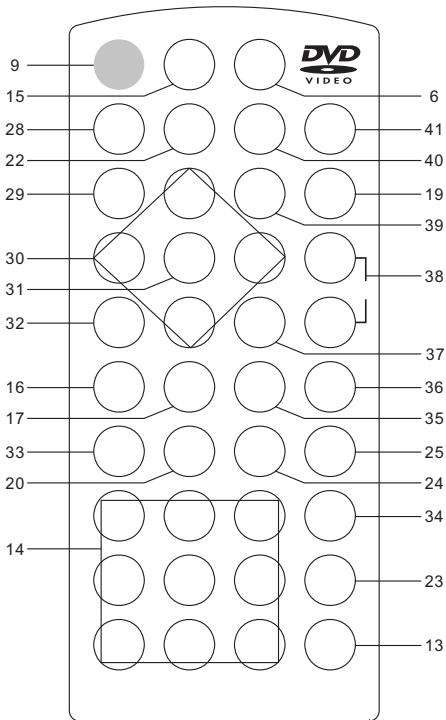

- Do not put in a trouser pocket.
- Keep away from food, moisture and dirt.
- Do not place in direct sunshine.

Battery replacement

Battery type: a button cell lithium battery (CR2025 3V)

1. Opening the battery case
Slide out the battery cover while firmly pressing in the direction of the arrow.

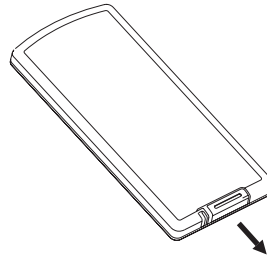

2. Replacing the battery
Put the battery in the case with the (+) indication upward as shown in the illustration.

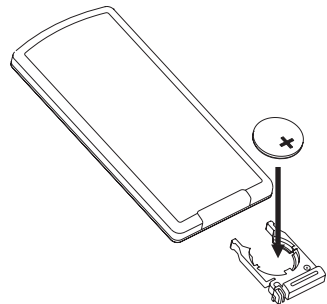

3. Closing the cover
Slide the cover as illustrated until a click is heard.

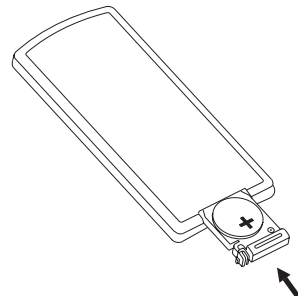

Preparing The Remote Control

When using the Remote Control

- * Before you using the remote control, please take the transparent insulator slice off the bottom of remote control.
- * Point the remote control at the remote sensor (11) within 2 meters.
- * It may not be possible to operate the remote control if the remote control sensor is exposed to direct sunlight.
- * Operation angle: about $\pm 30^\circ$ in each the direction of the front of the remote sensor.
- * The remote control is a small, lightweight precision device. To avoid damage, short battery life, operational errors and poor response, observe the following.
 - Do not subject the remote control to excessive shock.

Using The Detachable Front Panel

Removing the front panel

1. Press the release  button (7) to flip down the front panel.

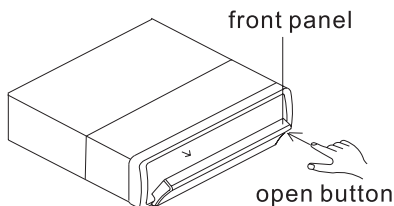

2. Take away the front panel.

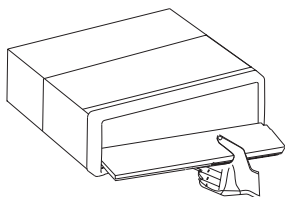

3. Keep front panel into the case.

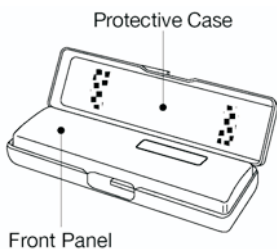

INSTALLING THE FRONT PANEL

Install the front panel back into its bracket and then push it back to the position for playing.

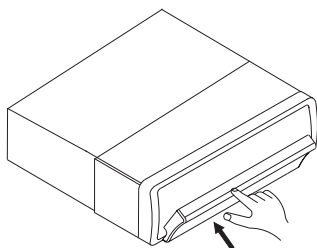



General Operation

Initial System Start-Up

Be sure to press the **RESET** button (12) when using the unit for the first time, after all connections are completed correctly.



1. Turn off the unit power.
2. Press **RESET** with a ballpoint pen or similar pointed object.

Turning Power On And Off

Turn on the unit by pressing any button (except  button (7) and  button (4)) or inserting a disc to disc slot (5).

When system is on, press  button (9) to turn off the unit.

Loading/Removing a Disc



1. Press  button (7) to flip down the front panel.
 2. Insert the disc into the disc slot (5) with the printed side facing up; the player will play the disc automatically.
- Whenever press  button (4) to eject the disc.

Adjusting sound quality

- Adjusting the volume level

Rotate the **VOL** button (10) or press **VOL (+/-)** button (38) to adjust the volume level.

- Adjusting Bass /Treble /Balance /Fader/EQ/Loud/Subwoofer

1. Press **VOL** button (10) repeatedly to choose the desired mode. Also press **MENU** button (37) and then press / button (30) to choose the desired mode. Each pressing the button changes the modes as follows:



Bass level: -7 ~ +7

Treble level: -7 ~ +7

Balance: 15L ~ 15R

Fader: 15R ~ 15F

EQ: Flat, Classes M, Pop M, Rock M

Loudness: ON/OFF

Sub-woofer: ON/OFF

2. Rotate the **VOL** button to choose the

desired item. Also press ◀/▶ button (30) to choose the desired item.

Display/Adjust Time

1. Displaying time:

Press **DISP** button (15) to show current information and time on the LCD. Return to original status after 5 seconds.

2. Adjusting time:

- 1). Press and hold **DISP** button (15) until the clock begins blinking.
- 2). Press ◀/▶ or ▶/▶ button to move to between hour area and minute area.
- 3). Rotate **VOL** button (10) or ▲/▼ to adjust hour or minute.

LCD Display

Exhibit current information and activated functions on the LCD display (8).

Flashing LED

The LED (26) will flash if the front cover is not inserted into the main unit.

ESP function

If the unit has the electronic shockproof function, it can be shockproof about several seconds:

- CD, VCD: 18 seconds.
- MP3: 160 seconds.
- DVD: 6 seconds.
- MPEG4: 20 seconds.

Turning Loudness on/off

Loudness introduces a special low- and high-frequency emphasis at low listening levels. This compensates for the ear's decreased sensitivity to bass and treble sound. Press **LOUD** button (2) to switch loudness on/off.

Equalization

Press **EQ** button (3) repeatedly to cycle through the following equalization mode:
FLAT→CLASSICS→POP M→ROCK M
→DSP OFF

Mute Function

Press **MUTE** button (19) to mute down the sound instantly, press it again to recover previous volume level.

Mode Function

Press **MODE** (6) to switch between the DVD, AV and TUNER.

Last Position Memory

- During disc playback, if you press ⏻ button (9) to turn off the unit and then press the button again to turn on the unit, the DVD unit will resume playing from the point that it was interrupted.
- During disc playback, if you press **MODE** button (6) to switch to other mode, and then return to DVD mode again, the unit will resume playing from the point that it was interrupted.

Sub-Woofer Function

This unit is equipped with a sub-woofer output jack. When a sub-woofer is connects to this unit. Press **VOL** button (10) repeatedly to select SUBW and then rotate **VOL** button to turn sub-woofer output on/off.

Reset Function

RESET button on the housing must be activated with either a ballpoint pen or thin metal object. The **RESET** button (12) is to be activated for the following reasons:

- Initial installation of the unit when all wiring is completed.
- All the function buttons do not operate.
- Error symbol on the display.

Note:

If press **RESET** button(12), the unit can't work yet, please use a cotton swab soaked in isopropyl alcohol to clean the disc socket.

Radio Operation

Selecting The Frequency Band

Press **BAND** button (13) to select the desired band. The reception band will change between FM and AM.

Stereo/Mono

Press **ST** (1) or **MO/ST** (23) on the remote control to select mono/stereo mode.

Local/Distant

Press **ST/LOC** (1) for several seconds or **LO/DX** (34) on the remote control to select between local and distant stations. **LOCAL** setting is reception of strong station, and **DISTANT** setting is reception of weaker stations.

Selecting Station

- Press preset **1-6** button (14) to select a station which had been stored in the memory.

- Press **▶▶/◀◀** for several seconds until "MANUAL" appears on the display, and then press **▶▶/◀◀** button to select a station. If both buttons have not been pressed for several seconds, they will return to automatic seek mode .

Automatic Memory Storing & Program Scanning

- Automatic memory storing

Press **AMS** button (18) for several seconds, the radio searches from the current frequency and checks the signal strength until one cycle search is finished. And then 6 strongest stations are stored into the corresponding preset number button.

- Program scanning

Press **AMS** button (18) to scan preset station. When the field strength level is more than the threshold level of stop level, the radio is holding at that preset number for several seconds with release mute, and then searches again.

Station Storing

- Press **▶▶/◀◀** button to activate automatic

seek mode.

- In manual mode, press **▶▶/◀◀** button to select a station.

Press preset **1-6** button (14) for several seconds to store current station into the number button.

DISC Operation

Playback

1. Insert a disc with the label side facing up; the disc will be pulled into the unit automatically. Display the console information of the current disc on the screen.

2. For CD:

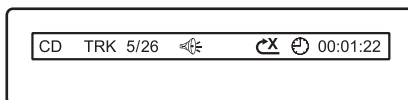

3. For MP3:

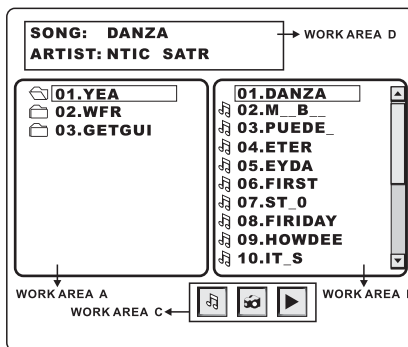

1). Press **◀/▶** button to move between work area A, B and C.

2). Press **▲/▼** button to select the desired folder or file of this work area.

3). Press **ENTER** button (31) to confirm the selected item.

Selecting Tracks In Single Step

- Press **◀◀** button (16) or **▶▶** button (17) to skip to the previous track or the following track. Track number shows on display.

- Press and hold **◀◀** button (16) or **▶▶**

button (17) to fast reverse or fast forward. It return to normal mode when you release the button.

Pause Playback

Press ►|| button (20) to pause playback. Press it again to resume playback.

Stopping playback

- Briefly press the ■ button (24) to stop the unit playback. When the ■ button is pressed and then press ►|| button (20), resume to the normal playback.
- Press ■ button (24) twice and then press ►|| button to stop the playback and go back to initial track.

Fast-Forward / Fast-Reverse

1. Fast-Forward

Press button (36) during playback. Each time the button is pressed, the speed of fast-forward changes according to the disc as follows:

FORWARD 2X ➔ 4X ➔ 8X ➔ 20X

In fast-forward state, press ►|| button (20) to recover normal playback.

2. Fast-Reverse

Press button (35) during playback. Each time the button is pressed, the speed of fast-reverse changes according to the disc as follows:

BACKWARD 2X ➔ 4X ➔ 8X ➔ 20X

In fast-reverse state, press ►|| button (20) to recover normal playback.

Repeat Play/ Paragraph Repeat Play

- Repeat play:

When you want to repeat play whole disc, a track or a directory in the disc.

- 1) Press **RPT** button (22) repeatedly to select different repeat modes.
- 2) For different kinds of discs, pressing **RPT** button (22) has different effects.
For CD/VCD/SVCD:
REP 1→REP ALL→REP OFF

For MP3:

REP 1→REP DIR→REP ALL→REP OFF

For DVD:

REP CHAPTER→REP TITLE→REP OFF

NOTES:

REP 1: Only a track (file) is repeatedly playback.

REP DIR: Only tracks (files) in a folder are repeatedly playback.

REP CHAPTER: The chapter is repeatedly playback.

REP TITLE: The title is repeatedly playback.

REP ALL: A disc is repeatedly playback.

REP OFF: The mode returns to normal playback.

* Repeat feature does not support VCD 2.0 (PBC is on).

- Paragraph Repeat Play:

When you want to repeat play a desired paragraph. A-B repeat allows a passage to be repeated continuously.

Press **A-B** button (28) first at the start of the required passage.

REPEAT A-

Press **A-B** button (28) secondly at the end of the passage.

REPEAT A-B

Then the unit will repeat playing the passage you just set from A to B.

To revert to normal playback, press **A-B** button again.

REPEAT CANCEL

Playing In Random Sequence

Press **RDM** button (23) to switch the random mode on/off. If the random mode is on, tracks (files) on the disc will be play in random sequence.

Previewing All Tracks

Press **INT** button (21) to play first several seconds of each track on the current disc. Press the button again to stop intro scan and return to normal mode.

Unique DISC Operation

DISC Menu Operation

Menu-driven playback is possible while playing back a DVD with menu-driven feature or VCD with the PBC (PlayBack Control).

1). Press TITLE/PBC (33) button, the title list or disc menu will appear on the monitor.

2). Use the cursor buttons (▲/▼/◀/▶) (30) and ENTER button (31) to select item you want on the menu.

* On some discs, you can select the items by the numeric key (33).

Multi-subtitle Language Function

Some DVD has multiple subtitle language, the subtitle language can be switched during playback, or subtitles can be hidden.

Press **SUB-T** button (40) repeatedly to switch between multiple languages recorded on the disc. EX:

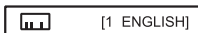

Notes:

- Not all discs will allow changing the subtitle during playback. In these cases, select subtitle from the DVD's menu.
- There may be a delay before the selected subtitle appears.
- For some discs, the subtitles will be displayed even when this is set to off.
- The language number is different according to the disc.
- Some discs only contain one subtitle language.

Multi-audio Language Function

For DVD:

You can select the language to listen to if the disc has multiple audio language. Press **AUDIO** (41) repeatedly to switch between multiple audio languages recorded on the disc. EX:



Notes:

- The language number is different

according to the disc.

- Some discs only contain one soundtrack language.
- Not all discs will allow changing the subtitle during playback. In these cases, select subtitle from the DVD's menu.

For VCD/SVCD:

For some VCD/SVCD discs with multiple audio channel. You can select the audio channel to play.

Press **AUDIO** button (41) repeatedly to switch between the audio channel recorded on the disc.

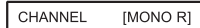
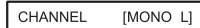

STEREO: To listen to normal stereo (left/right) playback.

MONO L: To listen to the left audio channel.

MONO R: To listen to the right audio channel.

Notes:

- Some discs only contain one soundtrack language.

Multi-angle Function

You can view the same screen at different angles if the disc has multi-angle views. Press **ANGLE** button (39) during playback. The following information will be shown on the screen.



EX: When the disc has 3 options
The angle switches between the angles recorded on the disc each time the button is pressed.

Notes:

- Some time may be required for the angle to change.
- Depending on the disc, the angle may switch in one of two ways.
 1. Seamless: The angle switches smoothly.
 2. Non-seamless: When the angle is switched, a still picture is displayed first, after which the angle switches.
- The angle number is different according to the disc.

- The function only works for discs having scenes recorded at different angles.

On Screen Display Function

Press the **SUB-T** button (40) for several seconds during playback to display the console information of the current disc on the screen.

Press **SUB-T** button (40) for several seconds continually, you will see the information as following:

FOR DVD:

DVD TT 1/2 CH 1/1 00:00:25

1/1 ENG 5.1CH 1/4 ENG OFF

For VCD:

VCD TRK 9/18 PBC 00:00:12

1)TT

Display the current title number and total title number.

2)CH

Display the current chapter number and total chapter number.

3)⌚

Display the played times of the whole disc.

4)C-:

Display the remaining times of the current chapter.

5)T:

Display the played times of the current title.

6)T-:

Display the remaining times of the current title.

7)C:

Display the played times of the current chapter.

8) 1/1 ENG 5.1CH 1/4 ENG OFF

Display the current disc language, audio type, subtitle language and play angle.

For VCD:

GOTO Function

Press **GOTO** button (25), the screen will display the following message:

FOR DVD:

DVD TT 01/12 CH001/001 00:00:39

Use the number keys (14) to input the desired Title, Chapter or Time, and then press **ENTER** button (31) to confirm.
FOR VCD:

VCD TRK 09/18 PBC 00:00:12

Use the number keys (14) to input the Track and Time then press **ENTER** button (31) to confirm.

ZOOM Function

Press **ZOOM** button (29) to enlarge or reduce the size of image according to the disc as follows:

ZOOM 2 → ZOOM 3 → ZOOM 4 → ZOOM 1/2
→ ZOOM 1/3 → ZOOM 1/4 → ZOOM OFF

In zoom in state, press **▲/▼/◀/▶** buttons (30) to move pictures up/down, left/right direction in order to find the picture that you want to zoom in.

Program Play Function

- In VCD/CD playback mode, press **PROG** button (34) can activate program edit interface as follow:

PROG			
1 []	5 []	9 []	13 []
2 []	6 []	10 []	14 []
3 []	7 []	11 []	15 []
4 []	8 []	12 []	16 []
PLAY		CLEAR	

Use **▲/▼/◀/▶** cursor button to select the item that you want to program.

1). The item you selected will become highlight.

2). Input the track number that you want to program by numeric buttons (0-9) on the remote control.

3). Press **▲/▼/◀/▶** cursor buttons to move to "PLAY" operation button and then press **ENTER** button (31) to program playback.

- In DVD/MP3 playback mode, press **PROG** button (34) to activate program edit interface as follow:

PROG			
T	C	T	C
1---	5---	9---	13---
2---	6---	10---	14---
3---	7---	11---	15---
4---	8---	12---	16---
PLAY		CLEAR	

Use ▲/▼/◀/▶ cursor button to select the item that you want to program.

- 1). The item you selected will become highlight.
- 2). Input the track number that you want to program by numeric buttons (0-9) on the remote control.
- 3). Press ▲/▼/◀/▶ cursor buttons to move to "PLAY" operation button and then press **ENTER** button (31) to program playback.

Frequently Asked Questions

- **When inserting a DVD disc, why it can't be played, just showing "region error"?**

It is because that the DVD player and the discs all have the "REGION CODE". If the region number described on the DVD disc does not correspond to the region number of this DVD player, the unit cannot play the disc.

- **When inserting a DVD disc, there is a window shown on the screen that requires entering 4 characters password, why?**

It is because that the current disc has "Parental Control" level, and the player's parental level is set below the level of the disc, you should enter the correct password to play the disc normally.

NOTE:

For how to set the "Parental Control" level, please refer to "Parental Control" on page 18.

Data Disc Play Operation

When you insert a data disc including audio (MP3), movie (MPEG4), picture (JPG) files into the disc slot, the following

media play window will be shown on the screen:

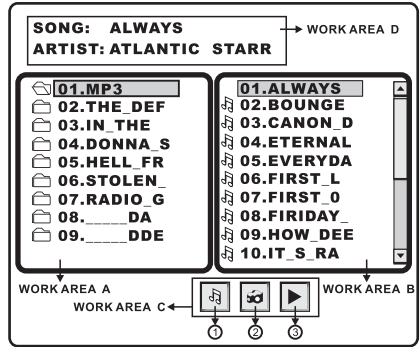

Explain as follows:

Work area A: folders list

Work area B: files list

Work area C:

(1): playback audio mode (default)

(2): viewing picture mode

(3): playback movie mode

Work area D: file information display

1. Press ◀/▶ button to move between work area A, B and C.
2. Press ▲/▼ button to select the desired folder or file of this work area.
3. Press **ENTER** button (31) to confirm the selected item.
4. In viewing picture or playback movie mode, if you want to return to the previous menu, press ■ (STOP) button.

Memory Card Play Operation

This disc player offers you a memory card slot (42).

Using the SD/MMC card:

When you insert a SD/MMC card into the memory card slot (42), the DVD player will read the SD/MMC card automatically. The unit gives first priority to the latter. If insert a disc into the disc slot (5) while read the SD/MMC card, the unit will play the disc. Press ■ (24) button to enter into PRE-STOP mode, then press **GOTO** button (25) to switch to the reading card mode.

Note:

When reading the memory card, please don't touch or take out the card. If following the instruction above, the unit can't read the card, please check if the card is in good condition, or tack out the card then insert it into the card slot once more.

USB Play Operation

This disc player offers you a USB slot (27). A USB driver can be connected through this slot.

Using the USB driver:

When you insert a USB driver into the USB slot (27), the DVD player will read the USB automatically. The unit gives priority to the latter. If insert a disc into the disc slot (5) while read the USB driver, the unit will play the disc. Press ■ (24) button to enter into PRE-STOP mode, then press **GOTO** button (25) to switch to the reading USB mode.

Note:

When reading the USB device, please don't touch or take out the device. If following the instruction above, the unit

can't read the device, please check if the device is in good condition, or tack out the device then insert it into the USB slot (27) once more.

The main unit can only support the standard USB-memory disc which is approved by Microsoft.

USB MP3 player is not a standard which means different brand name or different models have their own standard. So our product cannot support every MP3 player.

When connecting an MP3 player and there has normal battery in the player (non rechargeable battery), you should remove the battery from the MP3 player then connect it to the USB slot. Otherwise, it may cause battery burst.

When in USB play mode, be sure not to remove the USB driver from the USB slot.

AV In Operation

This disc player offers you the option of using the auxiliary A/V input jack (43) to connect a video game, digital camera/camcorder or other units you wish to use in your mobile audio/video system.

- 1). To connect with a mobile audio/video system by AV IN cable.
- 2). Press the **MODE** button (6) to switch to the **AV IN** mode on or off.

Setup

In DVD mode, when the disc is playing or in stop mode, press **SETUP** button (32) to enter setup menu.

1. When the cursor is on the topside, use ◀/▶ buttons to move between the different pages.
2. Press ▼ button to move the cursor to the setup page below and then you can use ▲/▼ buttons to move between the different setup options.
3. Press ▶ or ENTER button to move to the choice list of each setup option, and then use ▲/▼ buttons and ENTER button to change your selection.
4. When the setting is complete, press **SETUP** button (32) to return to normal mode.

** When settings are changed, old settings are overwritten. Make a note of the current settings before making changes. If the vehicles battery is disconnected, the settings will be cleared and will return to the factory settings.*

System Setup

When you open the setup menu, you will see the system setup page at first, see below:

SYSTEM SETUP
TV SYSTEM
SCREEN SAVER
TV TYPE
PASSWORD
RATING
DEFAULT
EXIT SETUP

TV SYSTEM

TV SYSTEM is used to select the TV output mode. This player can play discs recorded in either PAL or NTSC formats. Select NTSC format, when the unit is connected to NTSC TV. Select PAL format, when the unit is connected to PAL TV. Select AUTO format, the player TV output Change the TV mode among NTSC, PAL

and AUTO. The default setting is NTSC format.

SCREEN SAVER

Change the SCREEN SAVER on or off.

SETTING the TV TYPE

Use the procedure described below to set the output screen according to the type of TV monitor being used.

Setting contents: 4:3PS /4:3LB /16:9.

For some discs, the picture may not be set to the selected screen size. (For details, refer to the explanation on the disc's jacket.)

4:3 PS (PAN SCAN)

Select this when connected to a conventional 4:3size monitor. The picture will fill the entire TV screen. However, due to the mismatch in aspect ratio, parts of the movie at the extreme left and right sides will not be visible (when playing a 16:9 size movie).



This is selected upon shipment from the factory.

4:3 (LETTER BOX)

Select this when connected to a conventional 4:3 size (normal TV aspect ratio) monitor. There may be black bands visible at the top and bottom of the screen (when playing a 16:9 size movie). The width of these stripes will depend upon the original aspect ratio of the theatre release of the movie.



16:9

Select this when connected to a wide screen TV.



Password

Change the password locking or unlocking. Inputting numbers are displayed as "XXXX". The default password is "0000".

Parental Control

Use this function to restrict the viewing of movies to children of appropriate age levels only.

- 1) Press ▲/▼ button to select "PASSWORD" then press **ENTER** button.
- 2) The password input mode is activate. Use the numeric keypad "0" to "9" to input the 4-digit password, and then press **ENTER** button. The default password is "0000" upon shipment from the factory.
- 3) Press ▲/▼ button to select "**RATING**" then press **ENTER** button. The restriction level (parental level) input display appears.
- 4) Press ▲/▼ button to select the restriction level (1 to 8), and then press **ENTER** button.
- 5) When the setting is complete, press **SETUP** button to return to normal mode.

DEFAULT

Restore the system setup to the default setup.

Language Setup

When you open the language setup menu, you will see the language setup page:

LANGUAGE SETUP
OSD LANGUAGE
AUDIO LANG
SUBTITLE LANG
MENU LANG
DIVX [R] VOD
EXIT

You can change the OSD/ AUDIO/ SUBTITLE/ MENU language:
ENGLISH/GERMAN/SPANISH/FRENCH/PORTU
GUESE/ITALIAN/RUSSIAN/POLISH

Audio Setup

When you open the AUDIO menu, you will see the following picture:

AUDIO SETUP
AUDIO OUT
KEY
EXIT SETUP

- 1) AUDIO OUT: Change among SPDIF/OFF, SPDIF/RAW and SPDIF/PCM.
- 2) KEY: Change among b,-4, -2, 0, +2, +4, #.

Digital Setup

When you open the DIGITAL SETUP menu, you will see the DIGITAL SETUP page:

DIGITAL SETUP
OP MODE
DYNAMIC RANGE
DUAL MONO
EXIT SETUP

- 1). OP MODE: Change among LINE OUT/RF REMOD.
 - LINE OUT: LINE OUT mode, with digital dialog normalization.
 - RF REMOD: RF REMODULATION mode, with heavy compression and digital dialog normalization.
- 2). DYNAMIC RANGE: Change among FULL, 6/8, 4/8, 2/8, OFF.
- 3). DUAL MONO: Change among STEREO, MONO L, MONO R, MIX MONO.

Specification

1. GENERAL

Power Supply Requirements

DC 12 Volts, Negative Ground

Chassis Dimensions

178(W)x160(D)x 50(H)

Tone Controls

- Bass (at 100 Hz) ± 10 dB
- Treble (at 10 kHz) ± 10 dB

Maximum Output Power

4x60 watts

Current Drain

15 Ampere (max.)

2. DVD PLAYER

Signal to Noise Ratio

> 55 dB

Channel Separation

> 40 dB

Frequency Response

20Hz - 20 KHz

3. RADIO

FM

Frequency Coverage

FM: 87.5 - 107.9 MHz

IF

10.7 MHz

Sensitivity (S/N=30dB)

4 μ V

Stereo Separation

>25dB

AM

Frequency Coverage

530 - 1710 KHz

IF

450 KHz

Troubleshooting

If it appears that your DVD unit is faulty, first consult this checklist. It may be that something simple has been overlooked. Under no circumstances should you try to repair the player yourself, as this will invalidate the warranty. Only qualified service personnel can remove the cover or service this player.

No Power

- If the power supply is connected to the car accessory circuits, but the engine is not moving, switch the ignition key to "ACC".
- Check if the fuse is blown. Then replace the new fuse.
- Check if the on/off button on the front of the player is set to on.

No Picture

- Check if the monitor or TV is switched on.
- Check if select proper mode, such as Disc Play mode and AV mode.
- Check the video connection.

Distorted Picture

- Check the disc for fingerprints and clean with soft cloth, wiping from centre to edge.
- Sometimes a small amount of picture distortion may appear. This is not a malfunction.

Completely Distorted Picture

- The disc format is not according to the TV-set used (PAL/NTSC).

No Color in Picture

- The disc format is not according to the TV-set used (PAL/NTSC).

Disc Does Not Play

- Ensure the disc label is upwards.
- Clean the disc.
- Check if the disc is defective by trying another disc.

No Sound

- Check audio connections.
- If using a HIFI amplifier, try another sound source.

Distorted Sound from HIFI Amplifier

- Check to make sure that no audio connections are made to the amplifier phono input.

The Player Does Not Respond To the Remote Control

- Aim the remote control directly at the sensor on the front of the player.
- Avoid all obstacles which may interfere with the signal path.
- Inspect or replace the remote control battery.

Distorted or B/W Picture

- The disc format is not according to the TV-set used (PAL/NTSC).

No Audio at Digital Output

- Check the digital connections
- Check the Digital Audio menu to make sure that the digital output is correctly set.
- Check if the audio format of the selected audio language matches your receiver's capabilities.

Buttons Do Not Work

- Press Reset button on the housing of the DVD unit.

The Radio Does Not Work

- Check if the antenna cable is connected firmly.

The Radio Station Automatic Selection Does Not Work

- If the signals are too weak, select a station manually.